



Barre coupe-feu

1, 2, 3 OU 3 POINTS LATÉRAUX

Caractéristiques techniques

Généralités :

- Norme NF EN 1125:2008
- Résistance à la corrosion : 240 heures (Grade maximum prévu par la norme)
- Endurance > 200 000 ouvertures (Grade maximum prévu par la norme)
- Barre de 1130 mm en standard largeur totale 1285 mm
- Profil étroit 37 mm permettant la pose sur tout type de support (bois, alu, acier, pvc)
- Projection de la barre 95 mm
- Cache-tringle
- Hauteur 2270 mm
- Fabriqué en Italie

Particularités :

- Pêne acier anti-intrusion limitant les risques d'intrusion de l'extérieur vers l'intérieur
- Forme très arrondie limitant tout risque de blessure et tout risque d'accrochage en cas de sortie précipitée
- Manivelles anti-pince doigt

Pose :

- Réversibilité sans aucun démontage
- Platine de pose atelier permettant le transport de la porte nue et le montage au dernier moment sur le chantier
- Accrochage des tringles par simple encliquetage sur le boîtier central et blocage sur les pènes haut et bas ou latéraux par vis pointeau avec une grande marge de réglage
- Pênes latéraux pour éliminer les problèmes de gâche au sol

Accessoires : (pages 70 à 73)



Désignations	Gencod 8 02061	Références	Poids
1 POINT			
Barre CF, 1 point latéral, pêne acier, alu	416308 5	9411 113334A	2875 g.
Barre CF, 1 point latéral, pêne acier, blanche	416310 8	9411 113444A	2875 g.
Barre CF, 1 point latéral, pêne acier, noire	416309 2	9411 113554A	2875 g.
2 POINTS			
Barre CF, 2 points haut et bas, pêne acier, alu	416264 4	9412 113334A	4200 g.
Barre CF, 2 points haut et bas, pêne acier, blanche	416268 2	9412 113444A	4200 g.
Barre CF, 2 points haut et bas, pêne acier, noire	416269 9	9412 113554A	4200 g.
3 POINTS			
Barre CF, 3 points (1 latéral + haut et bas), pêne acier, alu	416281 1	9413 113334A	4300 g.
Barre CF, 3 points (1 latéral + haut et bas), pêne acier, blanche	416283 5	9413 113444A	4300 g.
Barre CF, 3 points (1 latéral + haut et bas), pêne acier, noire	416282 8	9413 113554A	4300 g.
3 POINTS LATÉRAUX			
Barre CF, 3 points latéraux, pêne acier, alu	416975 9	9416 113334A	5180 g.
Barre CF, 3 points latéraux, pêne acier, blanche	416974 2	9416 113444A	5180 g.
Barre CF, 3 points latéraux, pêne acier, noire	416973 5	9416 113554A	5180 g.



Barre coupe-feu

1, 2, 3 POINTS

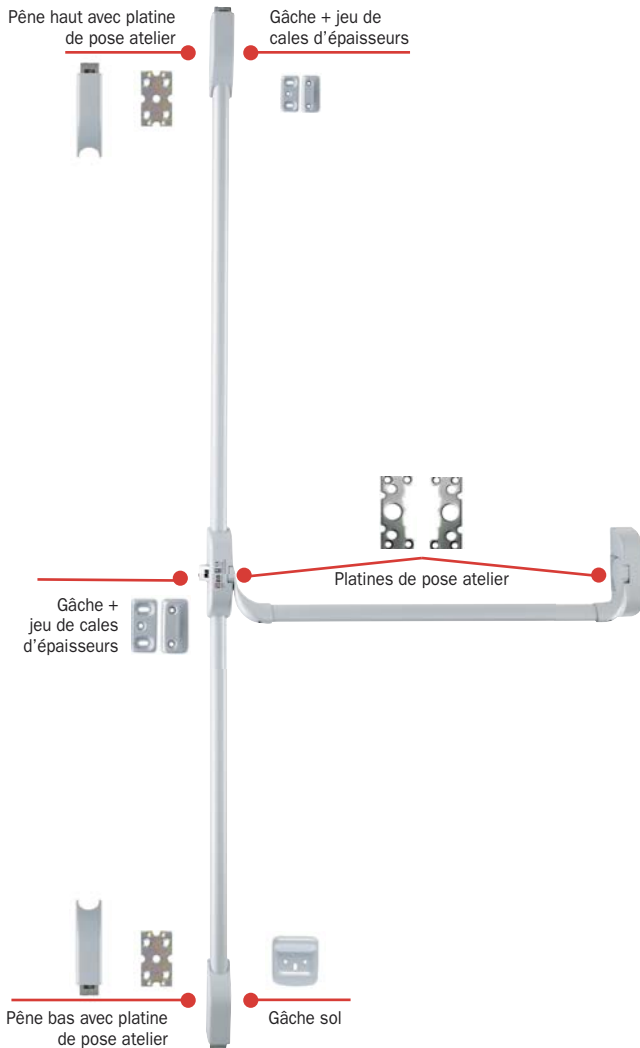
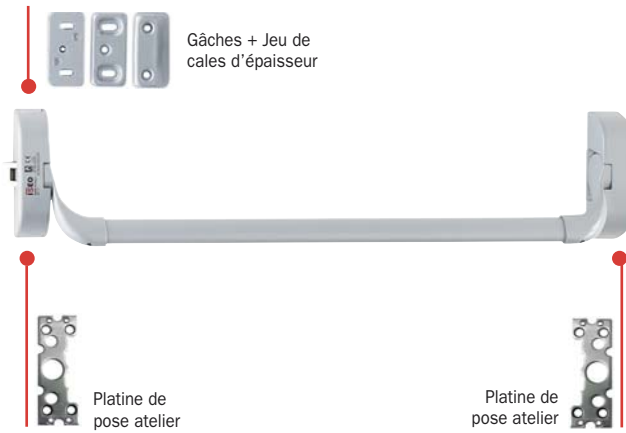

Dimensions

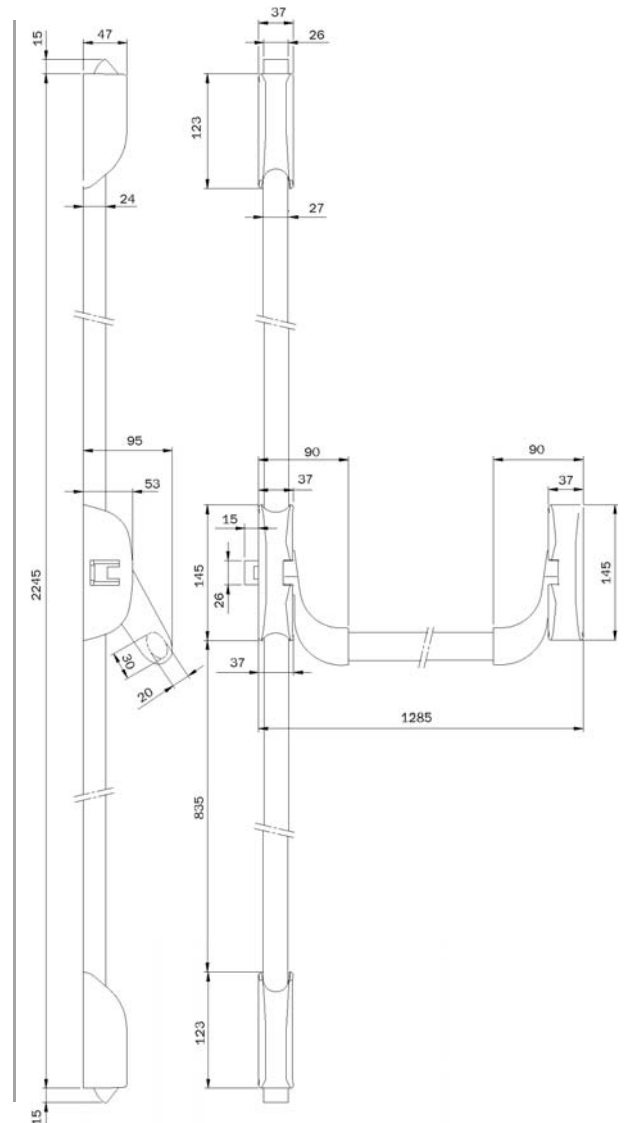
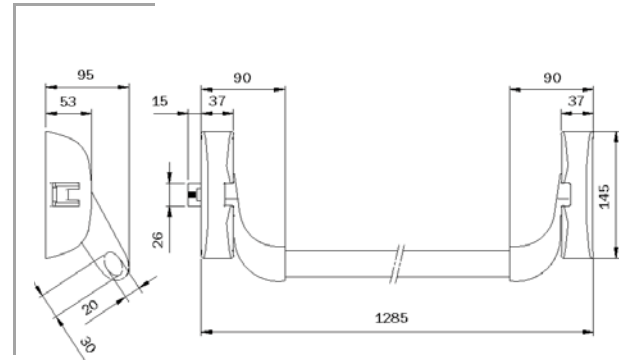



Barre coupe-feu

3 POINTS LATÉRAUX

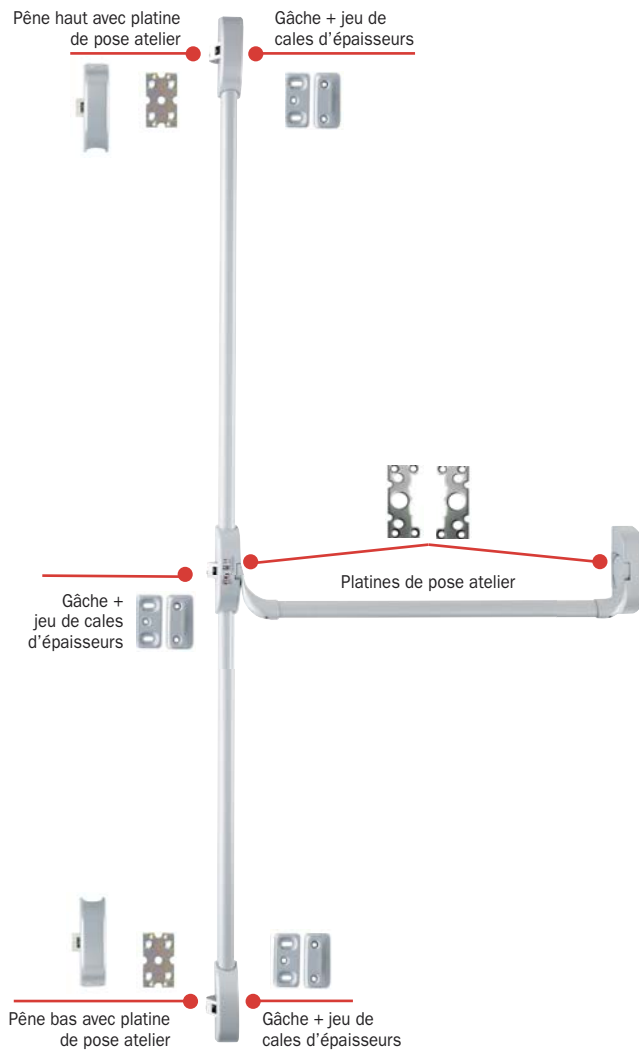

Dimensions

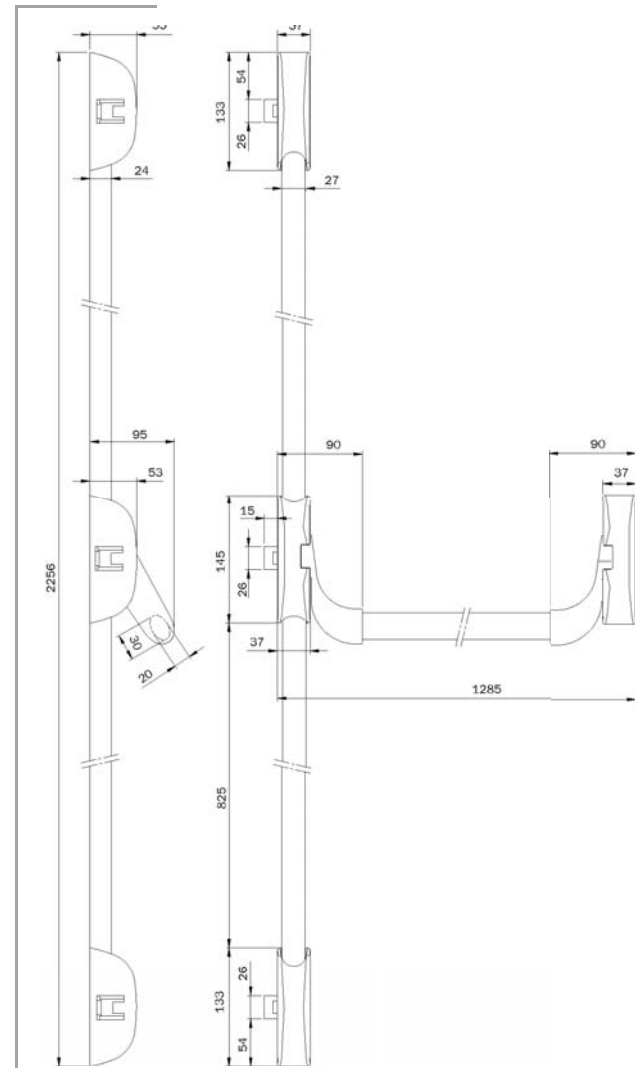

Barre : configuration pour porte 1 vantail











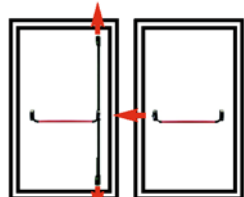
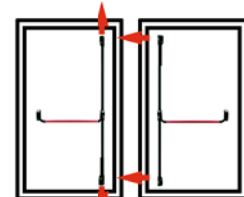
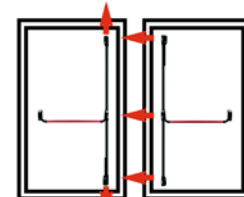
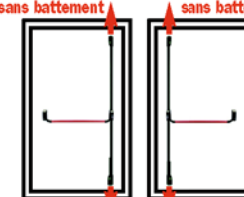





	9411113(xx)4A	9412113(xx)4A			9413113(xx)4A	9416113(xx)4A	
● INCLUS DANS LA RÉF. ○ À COMMANDER SÉP.							
9411113(xx)4	●	●	○	○	●	●	○
9410201(xx)5		●●		○○	●●		○○
9410003(x)04A				○			○
9410203(xx)5			○○			●●	
9410020(x) L = 2270 mm		●	○	○	●	●	○
L = 1130 mm	●	●	●	●	●	●	●
94100040	●●	●●	●●	●●	●●	●●	●●
94100050		●●	●●	●●	●●	●●	●●
9410012(x)		●			●		
9410010(x)	●		●●	●		●●●●	●●
9410011(x)	●	●	●●	●	●●	●●●●	●●
EN OPTION							
9401100(x)T 9401200(x)T 9401300(x) 9401400(x) 9402100(x)	○	○	○	○	○	○	○
94091105E							
94100060	○	○	○	○	○	○	○
94100070	○	○	○	○	○	○	○

● Inclus dans la référence ○ À commander séparément (en option)

Le nombre de ● ○ correspond à la quantité de pièces contenues dans la référence

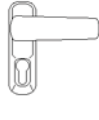
(x) voir référence coloris

Barre : configuration pour porte 2 vantaux

				
	9412113(xx)4A 9411113(xx)4A	9412113(x)4A	9412113(xx)4A 9416113(xx)4A	9412113(xx)4A 9412113(xx)4A
● INCLUS DANS LA RÉF. ○ À COMMANDER SÉP.				
9411113(xx)4 	● ●	● ○	● ●	● ●
9410201(xx)5 	● ●	● ●	● ●	● ● ● ●
9410003(x)04A 				
9410203(xx)5 		○ ○	● ●	
9410020x L = 2270 mm 	●	● ○	● ●	● ●
L = 1130 mm 	● ●	● ●	● ●	● ●
94100040 	● ● ● ●	● ● ● ●	● ● ● ●	● ● ● ●
94100050 	● ● ● ●	● ● ● ●	● ● ● ●	● ● ● ●
9410012(x) 	●	●	●	● ●
9410010(x) 	●	● ●	● ● ●	
9410011(x) 	● ●	● ● ●	● ● ● ●	● ●
EN OPTION				
9401100(x)T 9401200(x)T 9401300(x) 9401400(x) 9402100(x) 	○	○	○	○
94091105E 				
94100060 	○	○	○	○
94100070 	○	○	○	○

● Inclus dans la référence ○ À commander séparément (en option)

Le nombre de ● ○ correspond à la quantité de pièces contenues dans la référence

(x) voir référence coloris